

Installation guide Cold Water Filter

Before installing read this guide first



Contents of the pack

1. Bracket, Cold Water Filter cartridge and two tubes
2. T-piece, locking clip and two fibre washers
3. Elbow 3/8", four cable clips and three screws
4. T-valve 3/8" and two filter screens

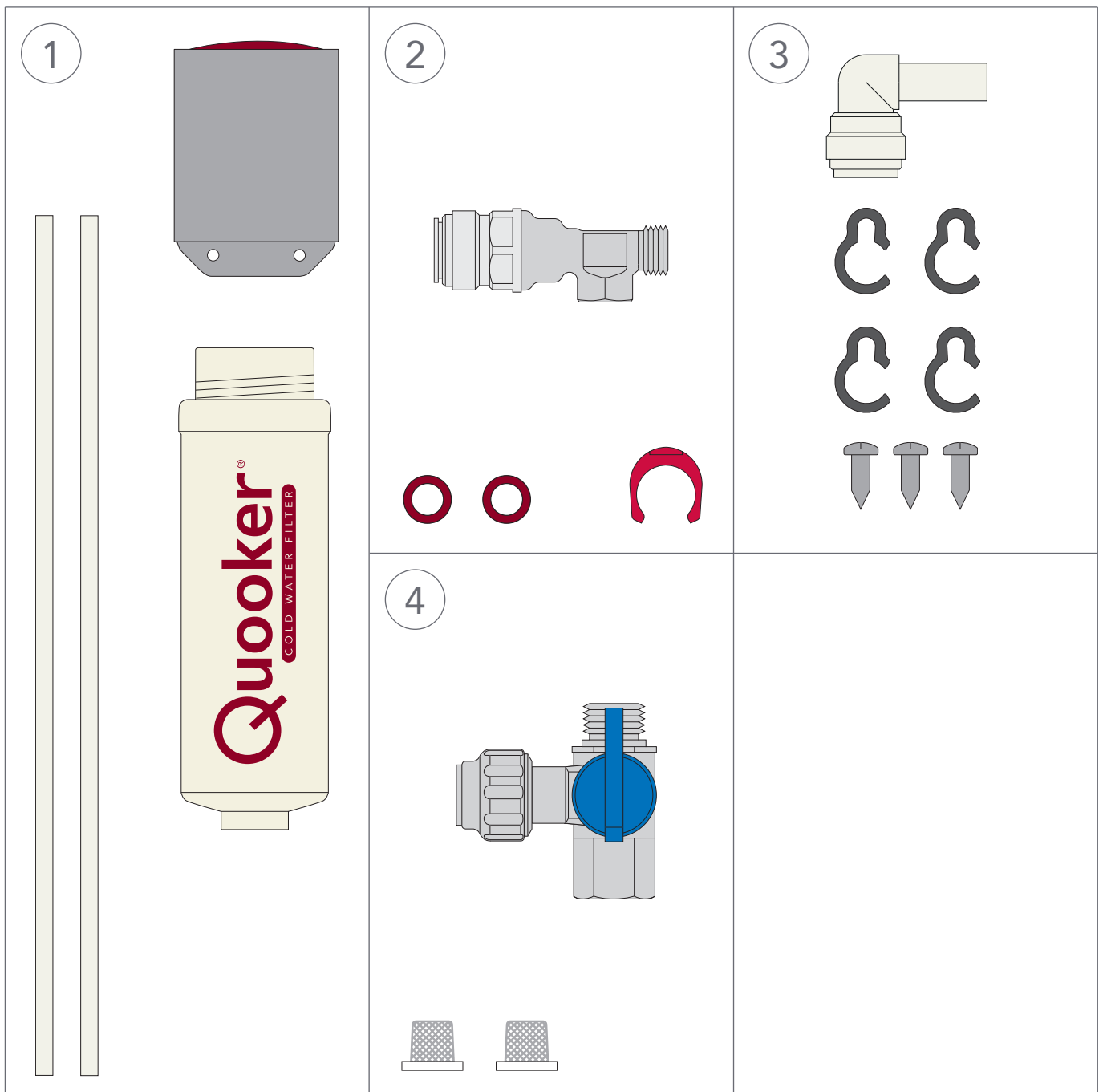

Overview of installation with Fusion tap

It is recommended that you install the Cold Water Filter in the following order:

- A. Fitting Cold Water Filter bracket
- B. Connecting water
- C. Connecting Cold Water Filter to tank
- D. Fitting Cold Water Filter cartridge

Please note: Bear in mind that the Cold Water Filter cartridge must remain accessible for periodic replacement purposes.

For an overview of the Cold Water Filter installation with the Flex or Nordic single tap, please refer to the following pages.

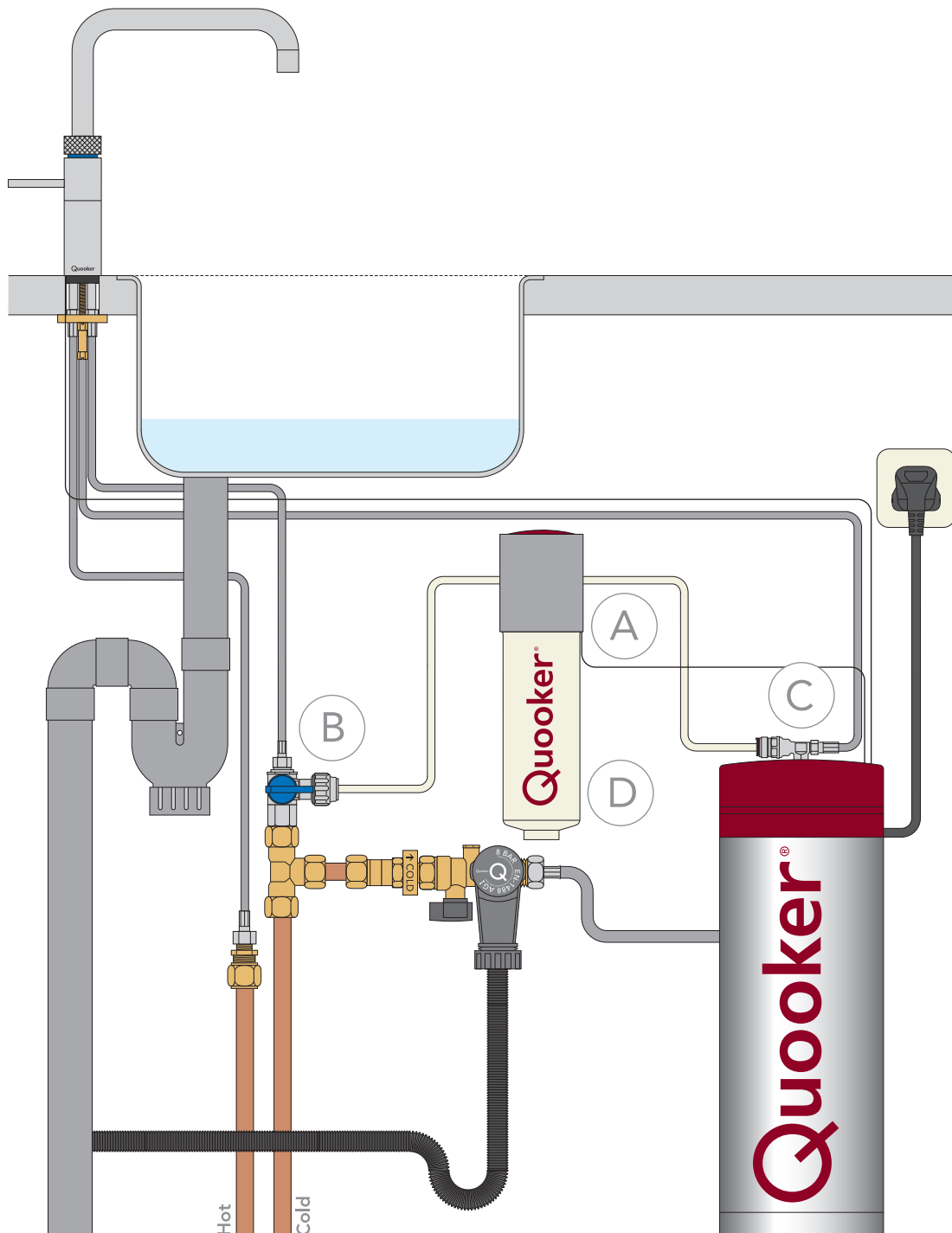

Overview of installation with Flex tap

It is recommended that you install the Cold Water Filter in the following order:

- A. Fitting Cold Water Filter bracket
- B. Connecting water
- C. Connecting Cold Water Filter to tank
- D. Fitting Cold Water Filter cartridge

Please note: Bear in mind that the Cold Water Filter cartridge must remain accessible for periodic replacement purposes.

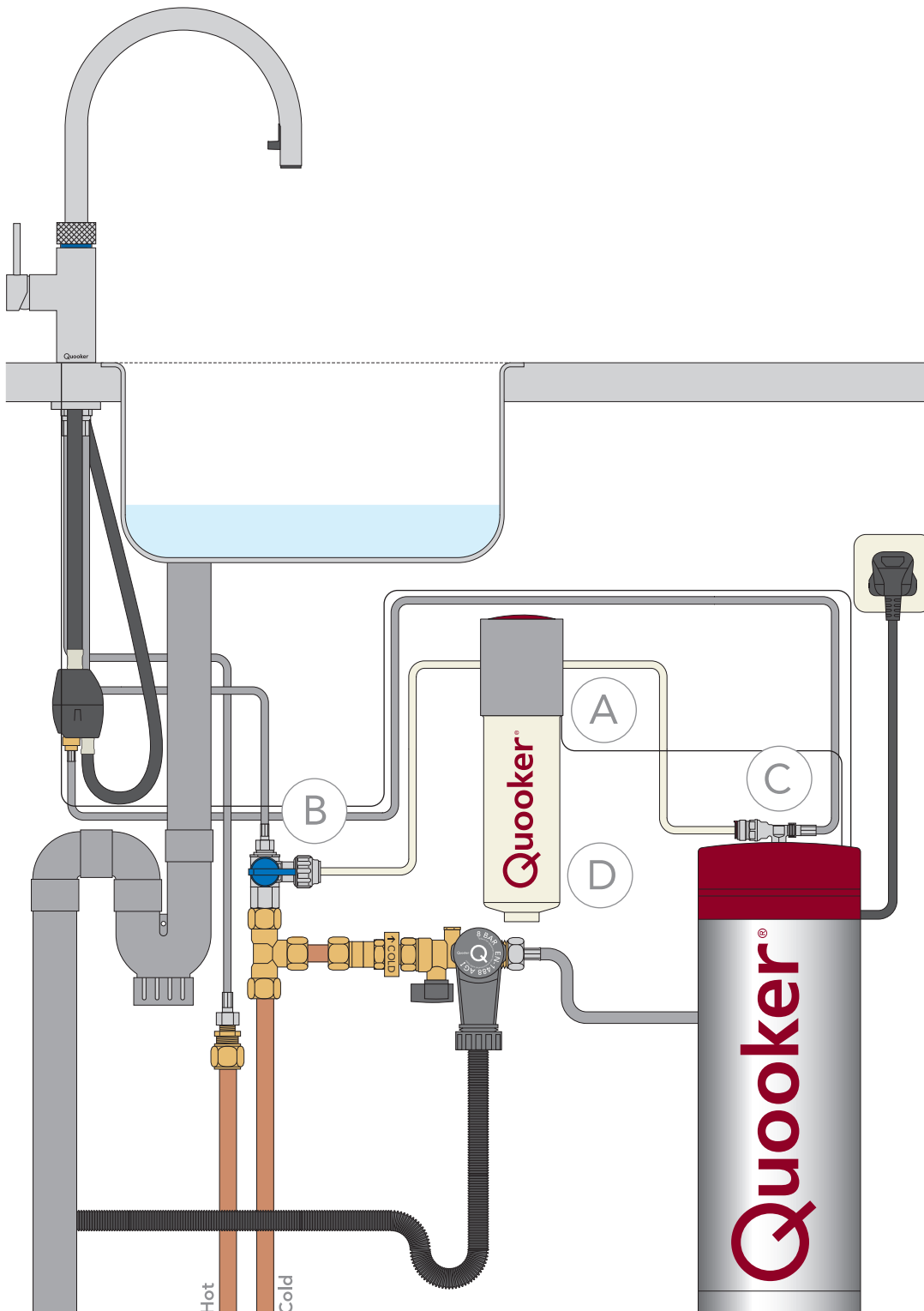

Overview of installation with Nordic single tap

- A. Fitting Cold Water Filter bracket
- B. Connecting water
- C. Connecting Cold Water Filter to tank
- D. Fitting Cold Water Filter cartridge

Please note: Bear in mind that the Cold Water Filter cartridge must remain accessible for periodic replacement purposes.

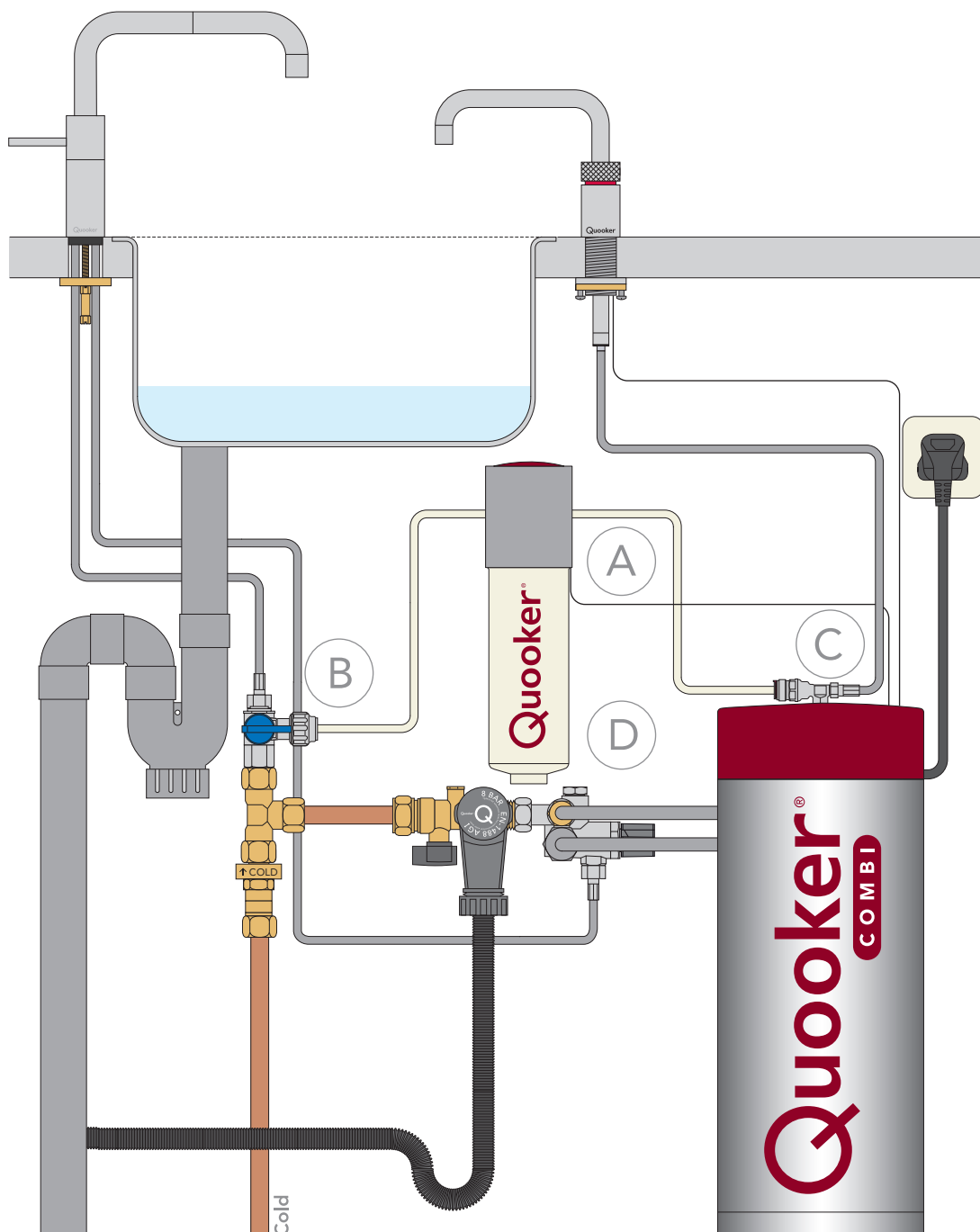

A

Fitting Cold Water Filter bracket

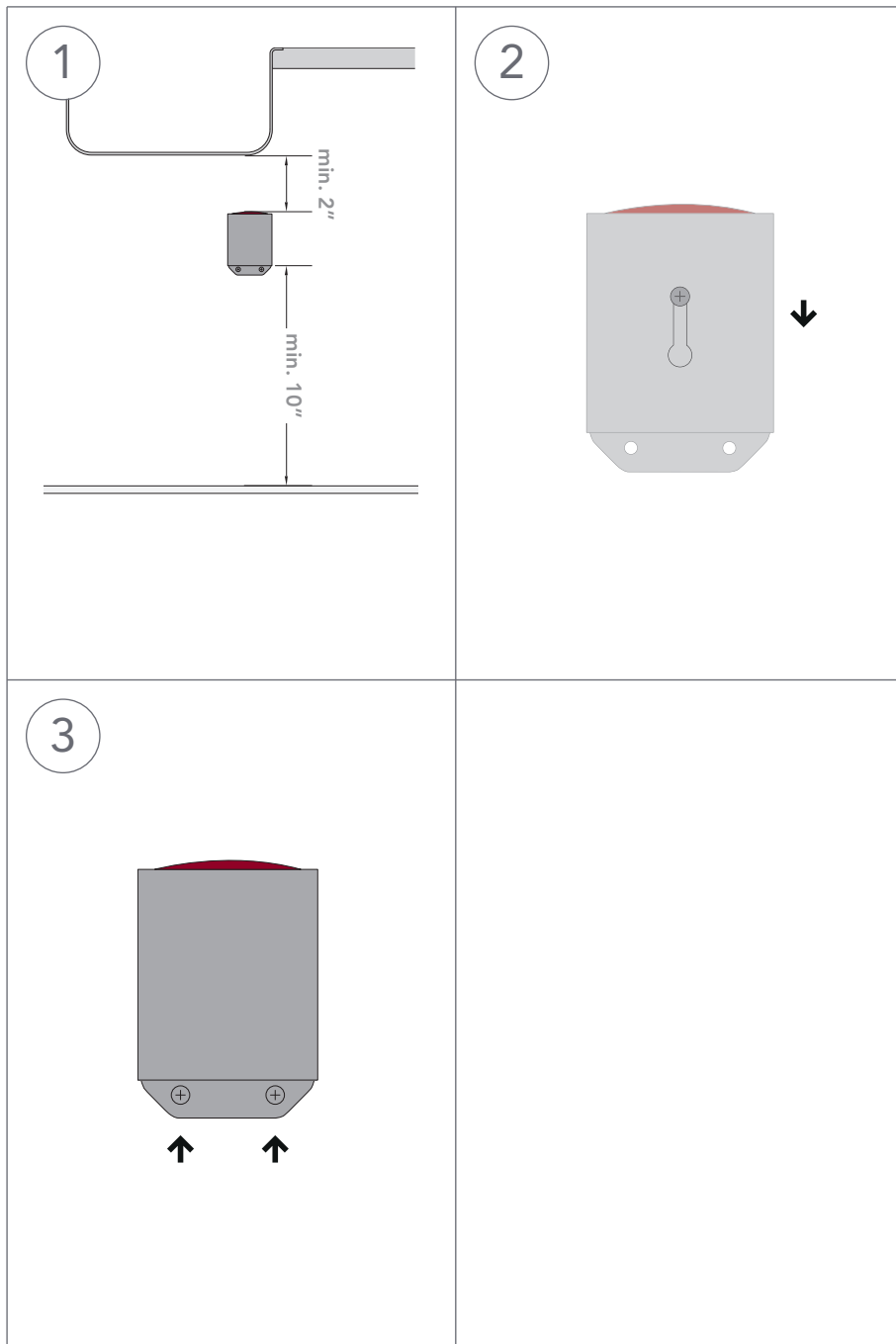

1 Positioning the bracket

Make sure that the bracket is positioned to set at least 2 inches from underside of the sink or work surface, with at least 10 inches of space between the base of the bracket and the base of the cabinet.

2 Fitting the bracket

Secure one screw at selected location and mount the Cold Water Filter bracket.

3 Securing the Cold Water Filter

Fixate the bracket by using the two remaining screws.

B

Connecting water

- When fitting the Cold Water Filter to an existing Quooker, switch off the Quooker by pressing the 'Q' button at the top of the tank and then unplug it from the socket.
- Please note: The plastic tubes will be connected to push fittings. No extra sealants are required. The plastic tubes should be installed without tension and sharp bends.
- When connecting the metal hoses, only the supplied washer or hose screen should be used. Do not use any liquid sealants.

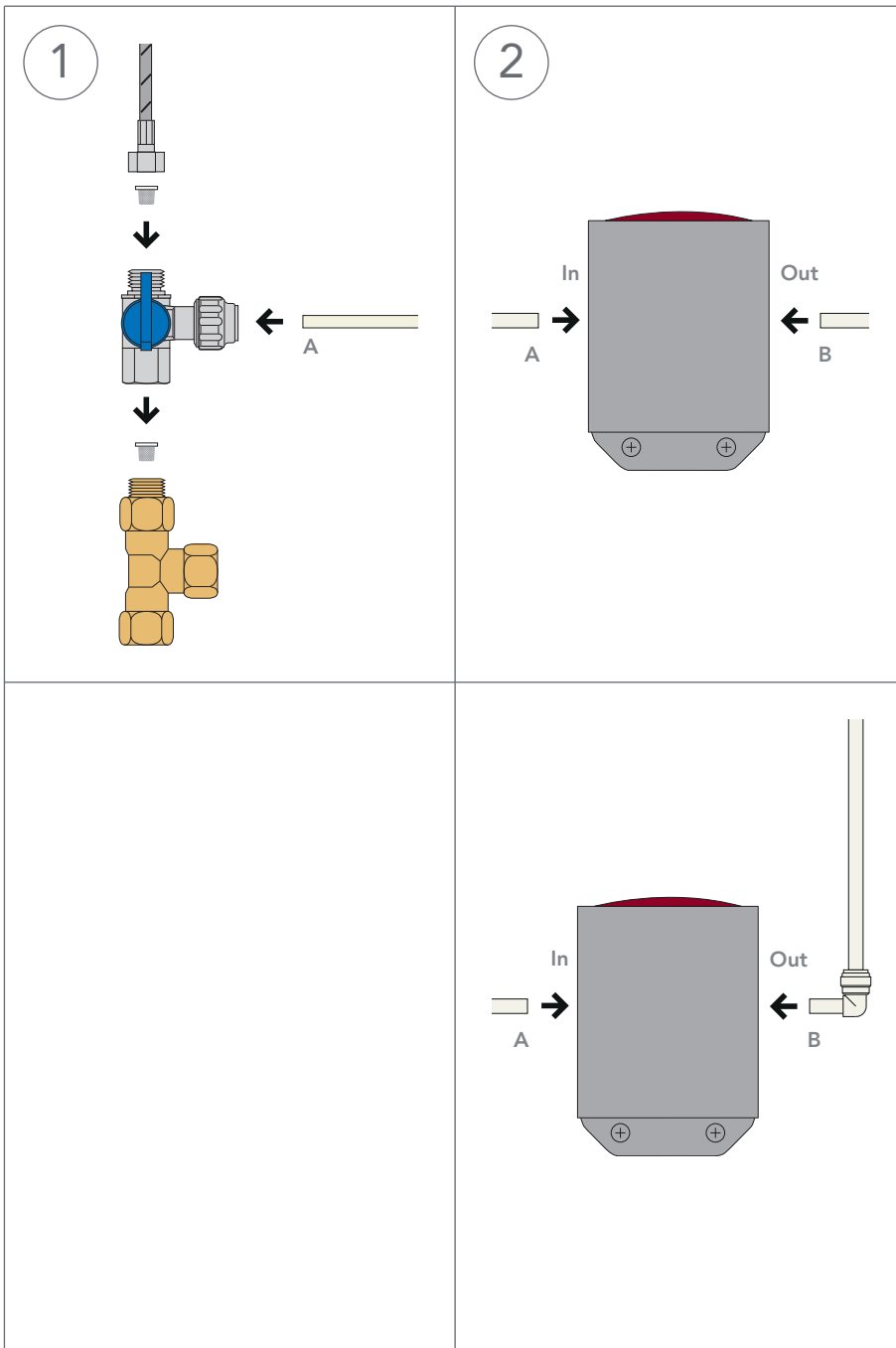

1 Connecting the T-valve

Shut off the main water supply. Disconnect the Fusion or Flex cold water supply hose. Connect the T-valve to the cold water supply using the supplied hose screen. Reconnect the Fusion or Flex cold water supply hose to the T-valve using another of the supplied hose screens and push the plastic tube (A) firmly into the T-valve.

2 Connecting the bracket

Push plastic tube (A) firmly into the inlet marked "IN" on the bracket. Push the second plastic tube (B) firmly into the outlet marked "OUT" on the bracket.

Optional

Use the elbow 3/8" when a sharp bend is desired.

C

Connecting with tank

- Important: Let the tap hose cool down before disconnecting.
- The tank cover has two jack-plug ports, one for your tap LED cable and a second covered port which will be used for the Cold Water Filter.

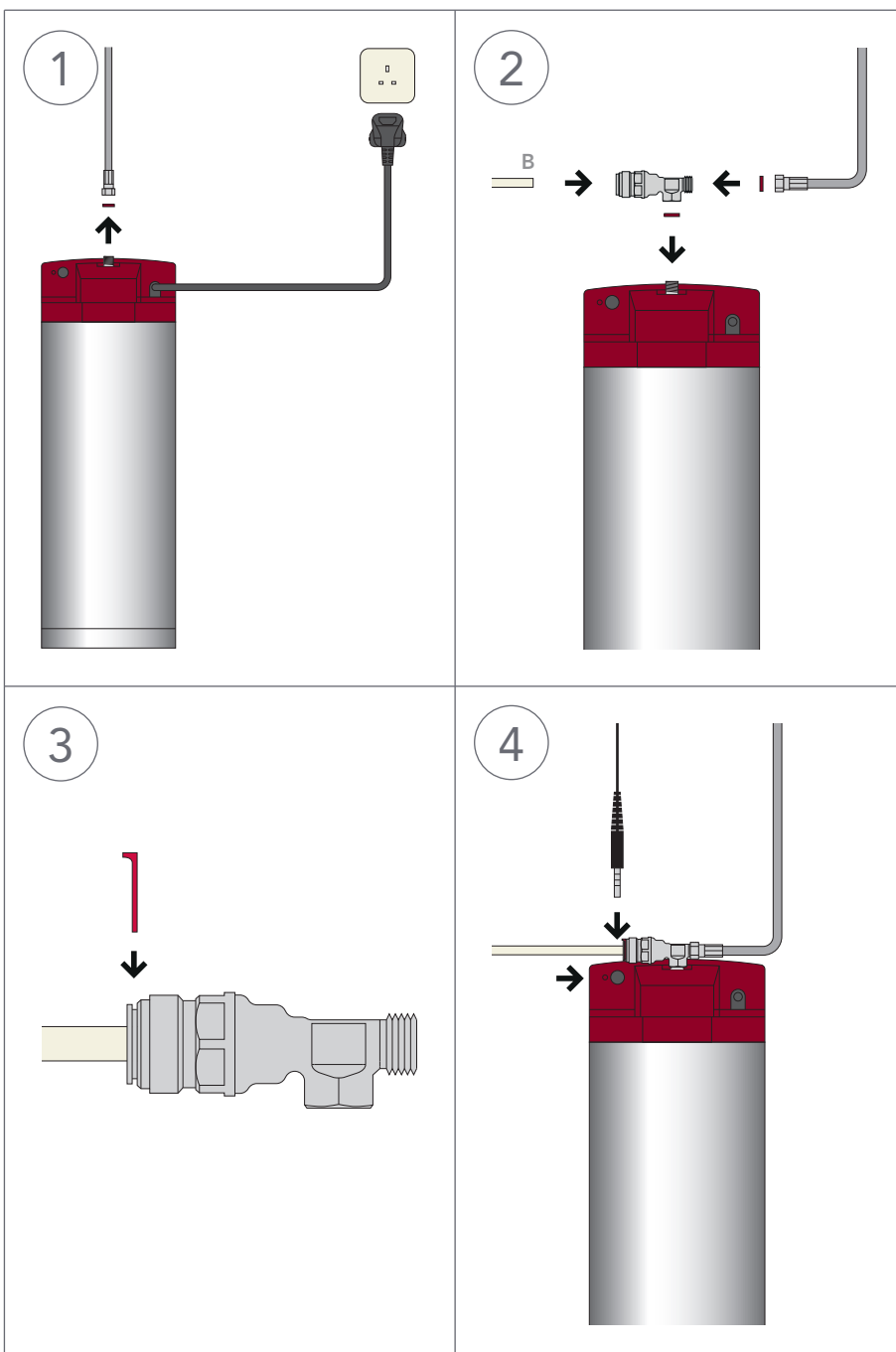

1 Disconnecting tank

Disconnect tap hose from the top of the tank using size 10 and 14 spanners.

2 Reconnect tank using T-piece

Connect the T-piece to the tank using size 10 and 14 spanners and the small fibre washer supplied. Connect the tap hose to the T-piece using the second small fibre washer. Make sure the tap hose does not block the jack-plug ports on the tank.

2 Place locking clip

Secure the T-piece using the locking clip.

4 Electrical connection

Remove the plastic protective cover from the second jack-plug port provided at the back of the tank cover. Connect the Cold Water Filter by plugging the LED cable into the second jack-plug port. Please note: the supplied cable clips can be added to route the LED cable along the plastic tubes.

D

Using Cold Water Filter

- The lifespan of a new Cold Water Filter cartridge is twelve months.
- After twelve months the Cold Water Filter will automatically give an audible signal after use of filtered water.
- The flow rate of the filtered water will be significantly lower than the unfiltered water.

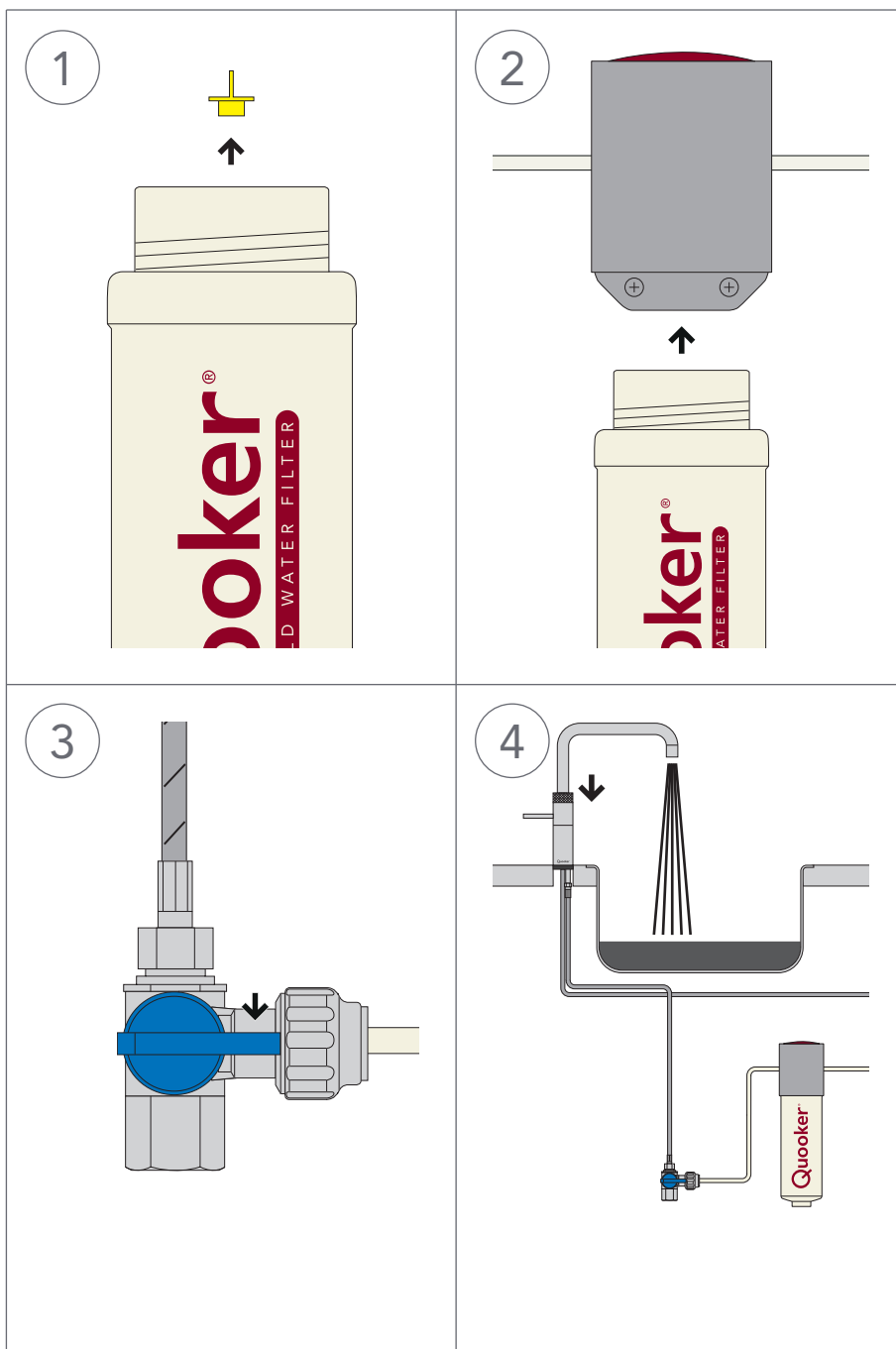

1 Preparing the cartridge

Remove the yellow plug from the water filter cartridge.

2 Fitting the cartridge

Screw in the cartridge by turning it anticlockwise until it stops. Do not overtighten.

3 Opening the T-valve

Open the T-valve by turning the blue handle in line with the plastic tube.

4 Flushing the cartridge

Switch on the main water supply and check for leaks. Plug the tank into the socket and turn it on. To activate filtered water, hold down the handle (textured ring) until the LED turns blue, then turn. Let the water run through the cartridge for 5 minutes before use. Black water will flow out initially. This is Norit carbon from the filter and is completely harmless. If the Cold Water Filter function is not available immediately, turn the Quooker off and on again.



www.quooker.co.uk